

VWTA3357-L

**MOBILE VIDEO WALL TROLLEY,
MODULAR 3X3**
FOR 50"-57" SCREENS, LANDSCAPE

With its modular design, VWTA3357-L allows the installation of nine 50"-57" screens in 3x3 landscape orientation. VWTA3357-L is characterised by high-end quality and aesthetics. Durable aluminium design and braked castors ensure high mobility, and as such VWTA3357-L enjoys great interest among exhibitors during trade fairs and conferences. The mounted accessories (computer shelf) and mini PC mount make the VWTA3357-L mobile structure suitable for places where there is a need for dynamic and effective communication with the audience, displaying and instantly updating information on the video wall.

FEATURES

- High-end quality and aesthetics
- Durable aluminium design
- Up to 9 x 50"-57" screens
- Independent 8-point micro-adjustment ensures perfect alignment of screens without the use of tools
- Screens protected against being slid out accidentally
- Integrated cable management system for smart installation
- Computer shelf and mount mini PC mount as standard
- Braked castors
- Screws protecting against accidental or unauthorised removal of the screen
- Possibility of mounting other accessories (e.g. shelves) on aluminium profile guides

PRODUCT SPECIFICATIONS

Short index	VWTA3357-L
Category	Mobile Video Wall Trolleys
Product group	Video Wall & Menu Board Mounts
Colour	Black
Warranty	Limited 5-years
Number of screens	9
Minimum screen size	50"
Maximum screen size	57"
Maximum load	290 kg
VESA Mounting Compatibility	100x100 up to 600x400

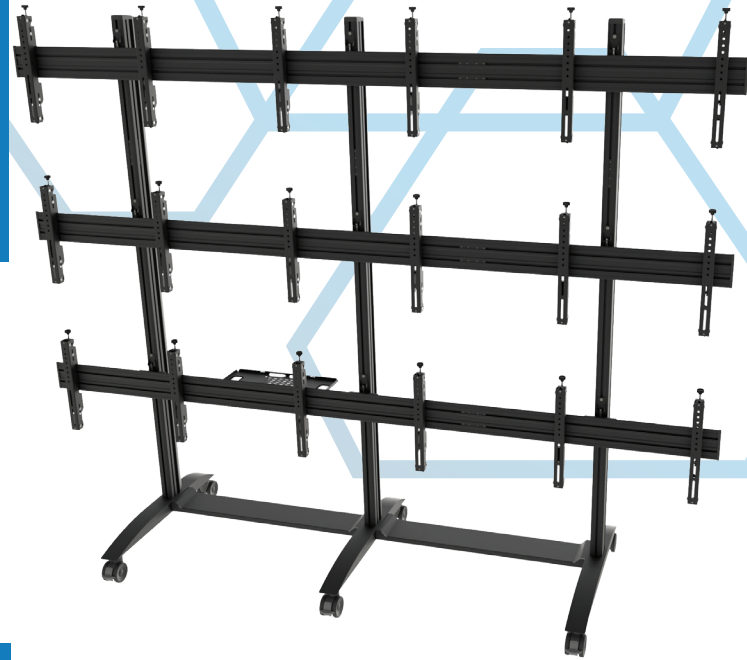

50"-57"



100x100
600x400



290 kg



RoHS
Compliant

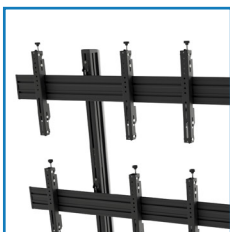

Securing the screen against falling with screws



Minimalistic design and functionality



Wide range of VESA mounting standards

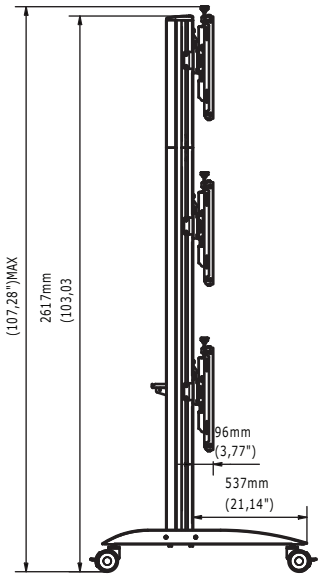
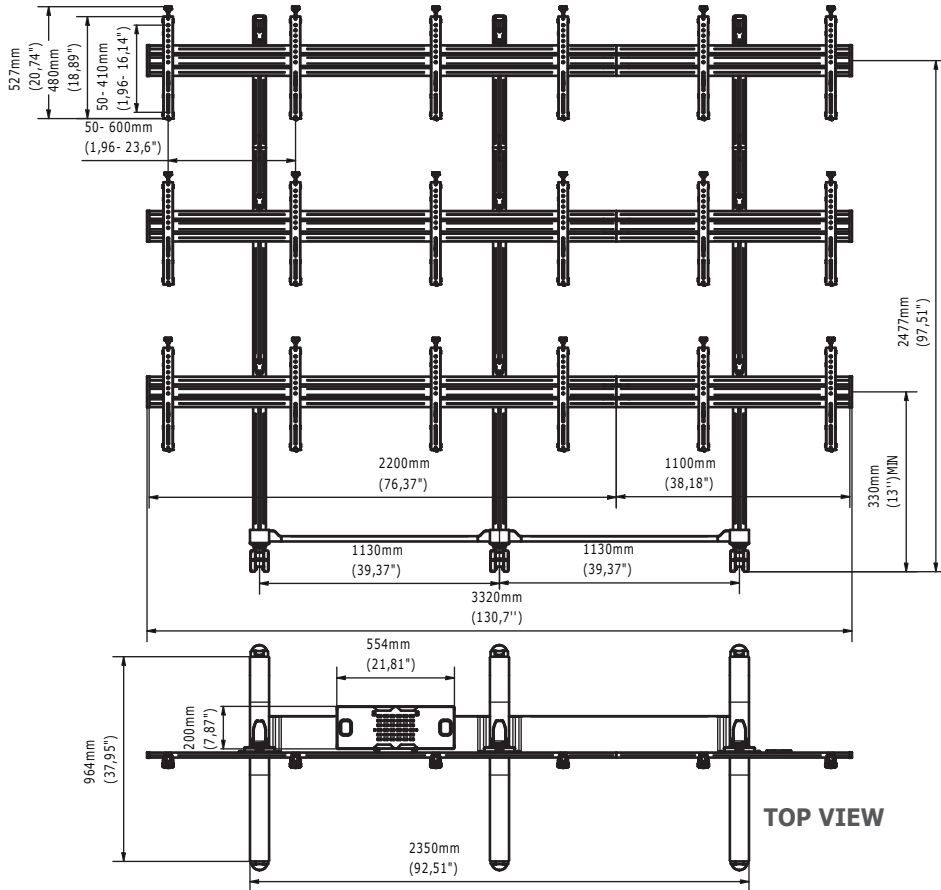

TECHNICAL SPECIFICATIONS

Product dimensions	W: 3320 mm D: 964 mm H: 2617 mm (W:130,71" D:37,95" H:103,03")
Product weight	144 kg (317 lb)
Max. distance from the surface	2477 mm (97,52")
Min. distance from the surface	330 mm (12,99")
Max. mounting pattern	600 mm x 410 mm
Min. mounting pattern	50 mm x 50 mm

LOGISTICS DATA

PLEASE NOTE - THIS PRODUCT IS PACKED IN SEVERAL CARDBOARD PACKAGES

SAP INDEX	EAN CODE	COLOUR	PACKAGE DIMENSIONS	PACKAGE WEIGHT
WWTR-VWTA3357-L	5902841112476	BLACK		

HS Code (Harmonized System): 732690, HTS Code (Harmonized Tariff Schedule): 7326909890, Country of Origin: Poland

ACCESSORIES AND RELATED PRODUCTS



VWTA3347-L

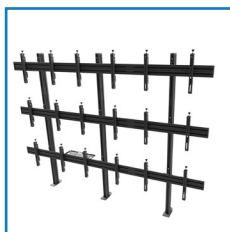

VWSA3357-L

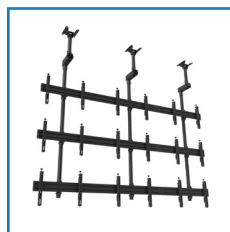

VWCA3357-L

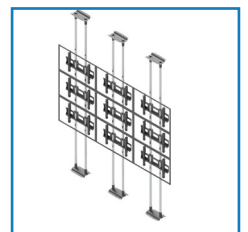

VWFCA3357-L

2021 - EDBAK Sp. z o.o. All rights reserved.
The information included in the specifications reflects the current technical specifications at the time of printing. We reserve the right to modify technical or physical specifications without prior notice. EDBAK name and EDBAK logo are registered trademarks of EDBAK Sp. z o.o. All EDBAK images and symbols are sole property of EDBAK Sp. z o.o. Edbak shall not be held liable for any loss or damage caused by incorrect installation or mounting. Copying this specification in whole or in part is only allowed after obtaining written consent from EDBAK Sp. z o.o.
VWTA3357-L-21.0601-EN