

## MONOBLOX

INSTRUCTION FOR MOBILE PROJECTION SCREENS  
MONOBLOX 32 AND MONOBLOX 64



## FOLDABLE LEGS

---

According to the size of the projection-screen five different leg types are available

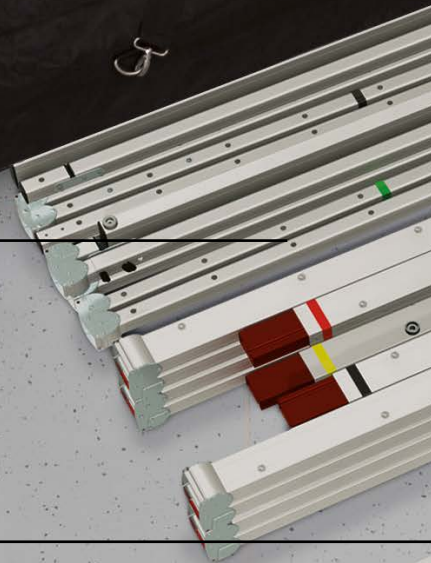

## VERTICAL MODULES

---

Vertical modules for Monoblöx 64  
By exchanging vertical modules of different length, the aspect ratio can be changed easily (4:3 - 16:9 - 16:10)

## WING SCREWS

---

Thumb screws in yellow bag



## PROJECTION SCREEN BAG

---

Lined storage bag for projection screen



## SOFTBAG WITH WHEELS

---

padded , tearproof nylonbag  
with wheels and carrying straps  
small 128x25x30 cm  
big 133x31x35 cm

## HORIZONTAL FRAME ELEMENTS

---

Compact transport volume  
due to patented snap joint technology  
Special extruded and hardened aluminum alloy  
allow maximum stability at minimum weight

## ASSEMBLY INSTRUCTION

---

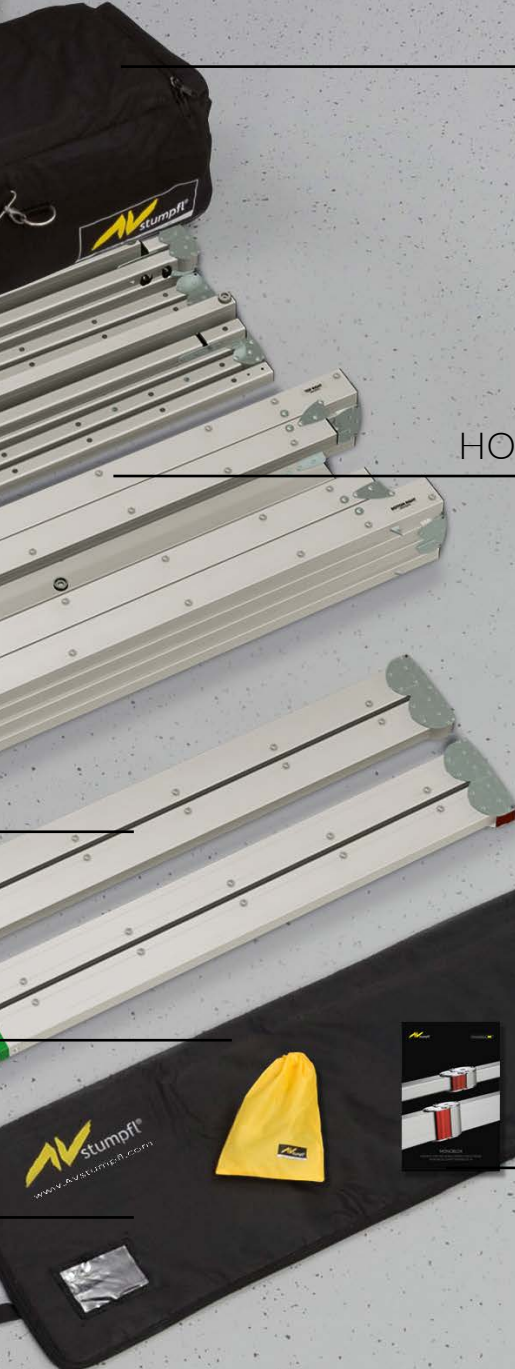

# INDEX

|   |    |
|---|----|
| GENERAL.....  | 5  |
| STANDARDS, REGULATIONS AND TECHNICAL SPECIFICATION..... | 5  |
| SAFETY.....   | 5  |
| OPERATION, MAINTENANCE AND SERVICE.....                 | 8  |
| WARRANTY.....   | 9  |
| MONOBLOX 64.....  | 10 |
| MONOBLOX 32.....  | 12 |
| FOLDABLE LEGS FOR VERTICAL ADJUSTMENT.....              | 13 |
| LEG TYPES.....  | 14 |
| SURFACE MOUNTING.....                                   | 15 |
| SET UP.....   | 16 |
| DISMANTLING.....  | 17 |
| ACCESSORIES.....  | 18 |

# GENERAL

## STANDARDS, REGULATIONS AND TECHNICAL SPECIFICATION

This projection screen is in accordance with the safety regulations in DIN standard 19045 and DIN 56950. The screen fabric is comply with DIN 4102 part 1 and the specifications of the according data sheet. For the technical details and projection-specific material parameters please refer to the corresponding product data sheet: [www.AVstumpfl.com/projectionmaterials](http://www.AVstumpfl.com/projectionmaterials)

Detailed data of frame components, legs and projection surface can be found on the type labels on each component and on the labeled soft bags, roller bags or flight cases.

## SAFETY

### GENERAL INFORMATION FOR THE MANUAL AND SAFETY

This operating manual forms part of the projection screen system and enables a safe and efficient operation. The safety section provides information about important safety aspects for the protection of persons, frame and projection materials. Task-related warnings/notes are also contained in the individual chapters. Read instructions through completely before proceeding and keep for future reference. You can find manuals electronically on our website: [www.AVstumpfl.com/downloads](http://www.AVstumpfl.com/downloads)

### PACKAGING MATERIAL

#### WARNING

Danger of suffocation!

- Keep packaging material and foils away from children.
- Do not let children play with packaging material.



#### NOTICE

Unpack without cutter or any other sharp tool to avoid damaging of the projection screen. Remove packaging materials by hand. Unpack projection surface after assembling of the frame.



## SET UP-ASSEMBLY

### MECHANICAL HAZARDS



Danger of injury due to improper assembly. Make sure all frame parts assembled correctly and all hinges and joints are locked before raising screen to standing position. Falling parts can cause severe injury or death!

### NOTICE

Projection surface damage in case of faulty assembly or set up. Make sure all frame parts assembled correctly and all hinges and joints are locked before one unfold and attach the projection surface.

### FRAME AND LEG COMPONENTS



Foldable snap joints, corner hinges and plug-in connections can lead to injury to the hands (body parts). Please be careful not to pinch your fingers!

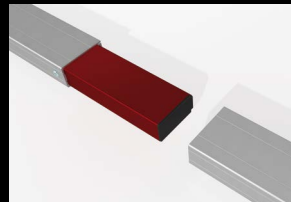
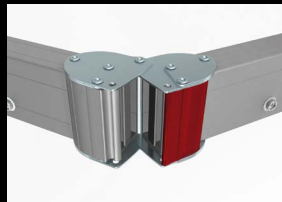
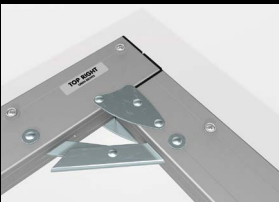

## FALLING OVER



Falling over of a projection screen can cause severe injury or death!  
To avoid falling over:

- Make sure that the projection screen is in level.
- Mind the maximum set-up height of the legs - Please follow the instructions in chapter LEG HEIGHTS (site 14)
- Prevent air draft
- Use additional weights on the base profile of the leg to gain higher stability.
- Use suspension points (e.g.: EasyFly) according to the overall system weight for additional safeguarding.

Do not put additional load on the screen frame!  
Do not use outdoors!

**⚠ WARNING**

Mobile projection screens are developed for indoor use only.  
Failure to follow warning may result in personal injury due to unforeseen acts of nature.  
Any damage and consequential damage caused by outdoor use is not covered by warranty.

**BASIC SAFETY REQUIREMENTS**

Basic safety requirements for „flying“ projection screens and wall- or ceiling mounting!  
If persons are able to stand under the loads, fastening points and slings must not be loaded more than half the value of the load bearing capacity stated by the manufacturer.  
When planning the event or production, not only dead loads but also dynamic forces, potential breakdown loads and additional loads during operation, as well as during assembly and dismantling must be taken into account.

Observe the local safety regulations!

**FLYING SCREEN**

If a modular projection screen is used as a “flying” (free hanging) screen, then all plug-in and clamp connections must be secured against becoming loose and falling.  
It is not allowed to use the projection surface holding the frame parts in position!  
Falling parts can cause severe injury or death!  
Please make sure that all components are secured safely before raising screen to standing position and lifting. Use the necessary number of suspension points (e.g.: EasyFly) according to the overall system weight. A second/auxiliary safeguarding system is mandatory (e.g. steel rope catch)  
Please follow the detailed instruction in the manual.

**⚠ WARNING**

**Falling parts**

It is not allowed to use the projection surface holding the frame parts in position! Falling projection screens or parts can cause severe injury or death!

**WALL- OR CEILING MOUNTING**

Before mounting, make sure that the wall or ceiling, as well as the fixing points meet the safety requirements of the local standards and the required load can be borne.

**⚠ WARNING**

**Falling parts**

Danger of injury due to improper disassembly.  
Falling parts can cause severe injury or death!

**⚠ CAUTION**

Please be careful not to pinch your fingers!

Beware of pinch points.



## DISASSEMBLY

For disassembly the same safety instructions apply as for assembly and set up. Bring down a projection screen with the appropriate number of people to avoid falling over of the screen.

### **WARNING**

Falling parts can cause severe injury or death!



**Falling  
parts**

## OPERATION, MAINTENANCE AND SERVICE

### FRAME ELEMENTS, LEGS AND ACCESSORIES

The frame elements, legs and additional elements are maintenance-free.

### PROJECTION SURFACE

#### FOLDING AND STORAGE

The projection surface is packed into a separate lined soft bag to avoid any damage by the frame parts, bleaching and discoloration.

Store the projection surface cleaned and dry at room temperature only!

Identical to the delivery condition, first halve and fold the surface with the projection side inwards on the shorter side in order to avoid soiling and damage to the surface.

The surface must be folded in such a way that the reinforced black border with the caps is on top of each other on all sides. Incorrect storage can damage and discolor the surface and is not covered by the guarantee. When folding the projection surface insert the enclosed foamed plastic foil between snap buttons and surface to avoid permanent marks.

### **NOTICE**

Additionally, following instructions have to be adhered to:

- Do not allow the projection surface to get in contact with sharp objects!
- Do not bring printed and coloring objects (instructions, magazines, etc.) in contact with the surface!
- Do not write on the projection surface!
- Colors penetrate the projection surface and cannot be cleaned anymore!

#### COLD BREAK

A projection foil must never be stored or transported below 5° C. There is a risk of a cold break! The film becomes very brittle and splinters like glass! When transporting the projection surface at low temperatures do not unfold the surface unless it has reached its full elasticity at room temperature. Otherwise there is the risk of cold break of the projection screen.

The ideal temperature range for assembling folding screens to prevent damaging the surface is 54°-82° F (12°-28° C). Assembling below recommended temperatures may damage surface and void warranty

#### CLEANING OF THE PROJECTION SURFACE

Use a white clean cotton cloth saturated with clear water (optionally mild soap water) and gently wipe the area in one direction (no circular motion). Wipe dry with another cotton cloth.

To clean a stubborn stain, use methylated spirit and follow the same procedure.

Clean rear projection surfaces in case of imperative only!



# WARRANTY

The warranty period for production deficiencies is 5 years for the frame elements and 24 months for the projection surface.

## NOTICE

Mobile projection screens are developed for indoor use only.  
Any damage and consequential damage caused by outdoor use is not covered by warranty.

The general terms and conditions are available at [www.AVstumpfl.com/agb](http://www.AVstumpfl.com/agb)

## LIMITATION OF LIABILITY

All the details in this manual were compiled in consideration of the standards and legal regulations applicable at this time, as well as the experience of the manufacturer and qualified staff. The manufacturer accepts no liability for damage to persons or things (projection screen, other devices, goods, etc.) resulting from:

- Non-observance of the manual and the regulations/safety instructions contained therein.
- Failure to comply with the local safety regulations.
- Inappropriate use (misuse).
- Use of unauthorized and non-trained staff.
- Unauthorized equipment conversions and technical modifications by the operator himself.
- Use of spare parts not approved by the manufacturer.
- Typesetting and print errors.

Failure to observe the above points will invalidate the warranty claims.  
Technical specifications are subject to change without notice.

The local regulations and safety regulations and the essential safety requirements apply for the use of this projection screen.

## DISPOSAL

At the end of its lifetime this product must not be disposed of with normal household waste but needs to be taken to a collection site for recycling.

Separate disposal of the product makes an important contribution towards environmental protection.

Frame components and legs are made of aluminum and steel.

The projection material is PVC vinyl.

Contact your local disposal company for the address of a collection center.

**SUBJECT TO MODIFICATIONS, ERRORS EXPECTED !**

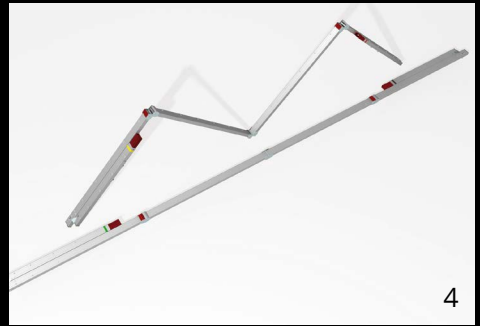
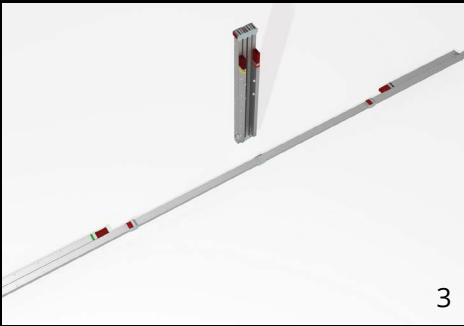
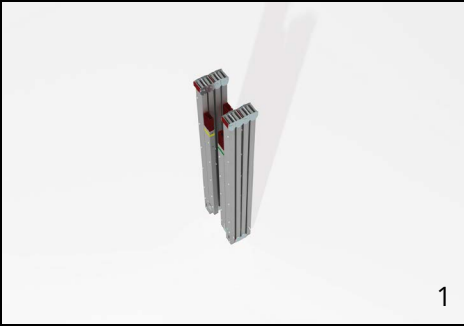

## MONOBLOX 64

The basic frame in System Monoblox 64 exists of 2 horizontal and 2 vertical frame elements, which have to be connected and screwed together with small wing screws.

**1-7** Open the folded horizontal frame elements (top and bottom) and the snap joints engage automatically.

**⚠ CAUTION** Beware of pinch points!

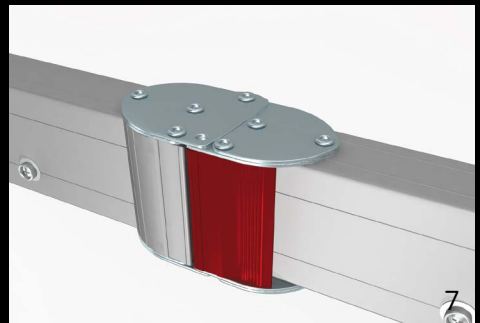
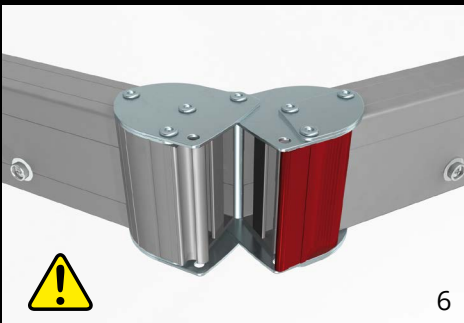

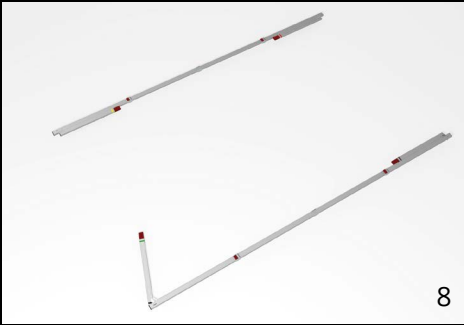

8

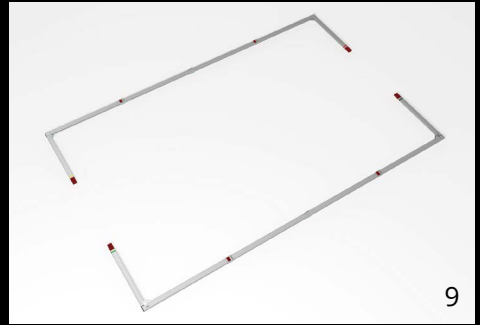

9

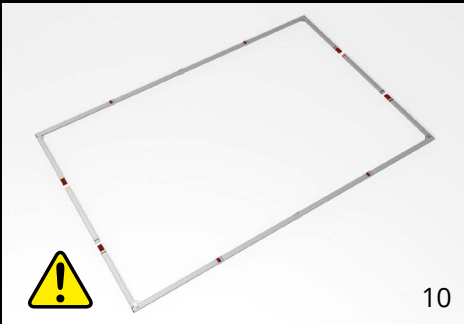

10

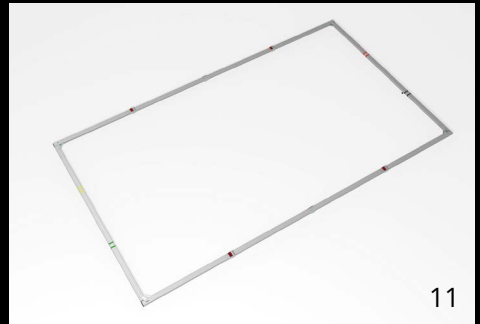

11

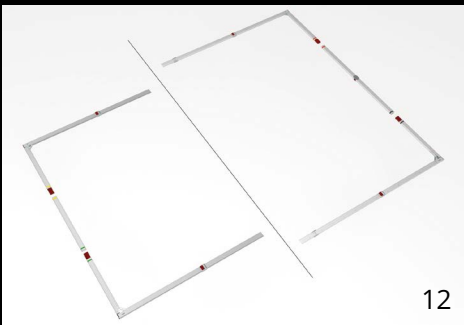

12

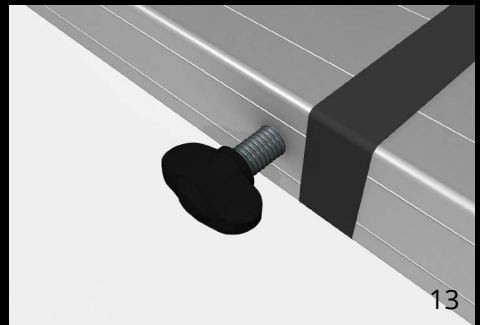

13

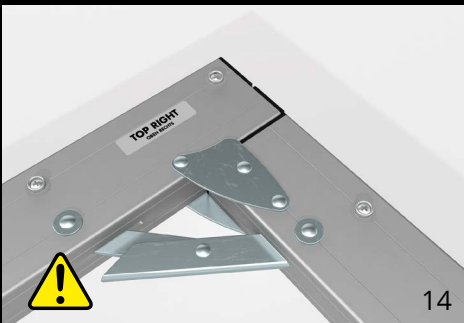

14

**8-11** Open the corners and plug-in the vertical elements. **12** Simply change the aspect ratio by using vertical modules of different length (4:3 - 16:9 - 16:10) **13** The vertical modules have to be secured with two wing screws M8x15. **14** Engaging the shear joints ensures the maximum screen stability.

**⚠ CAUTION** Beware of pinch points!

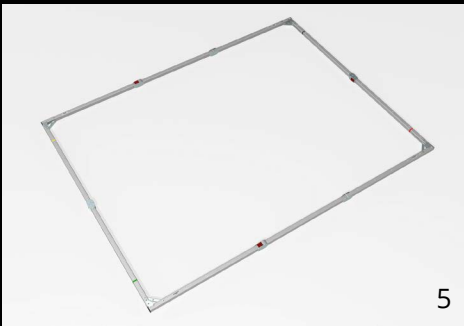
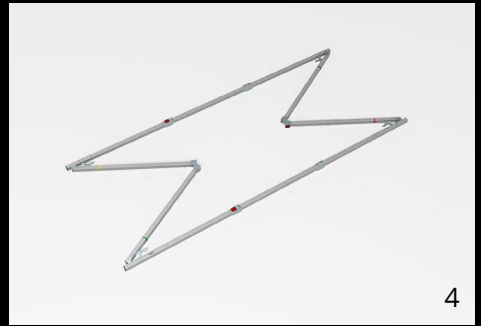
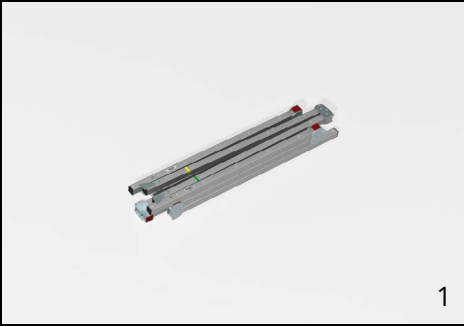

## MONOBLOX 32

**1-7** Open the folded frame horizontally and the locking hinges quickly engage and lock automatically. Pull the frame apart and the vertical frame parts lock into place.

**⚠ CAUTION** Beware of pinch points!

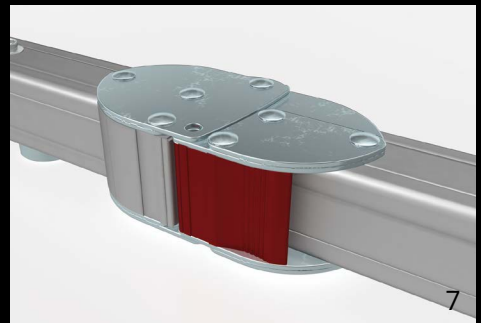
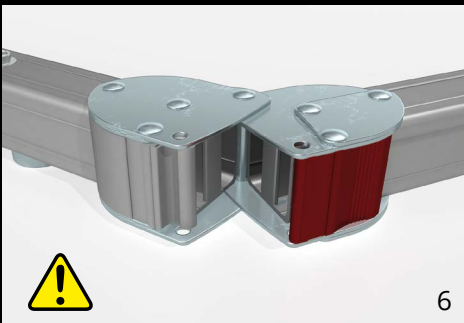

# FOLDABLE LEGS FOR VERTICAL ADJUSTMENT

The legs are foldable for compact transport volume. All profile elements are connected with snap joints or hinges inseparable.

## MOUNTING

**1** First open the vertical elements of the legs (with holes). **2-3** The snap joints engage automatically. **4** To secure the legs by a single person, we recommend the use of set up supports. Slide on with the upper round steel fork two set up supports each on the legs and center supports. Lay on the legs on the bottom bow and align the hole pattern matching the connection points at the desired set-up height. (Please follow the separate instructions for set up support) **5-6** The feet are secured with wing screws on the vertical frame elements. Note: Please find the instructions for telescopic support attachment under chapter SET UP

**⚠ CAUTION** Beware of pinch points!

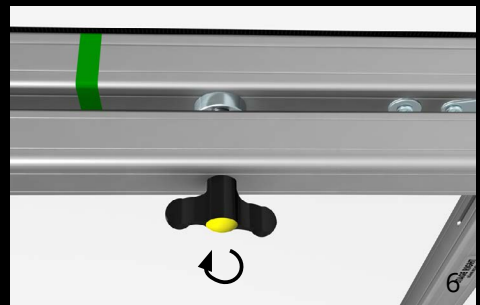
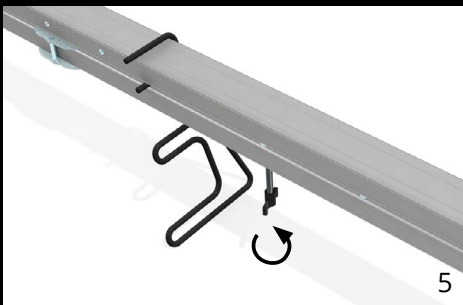
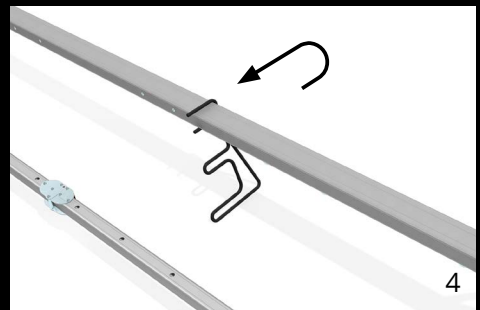
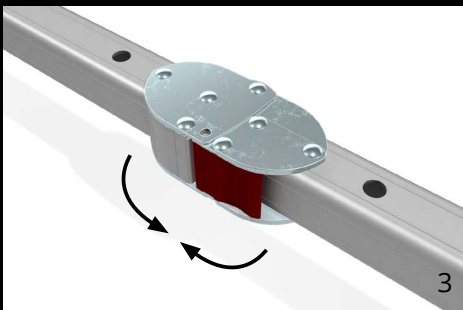
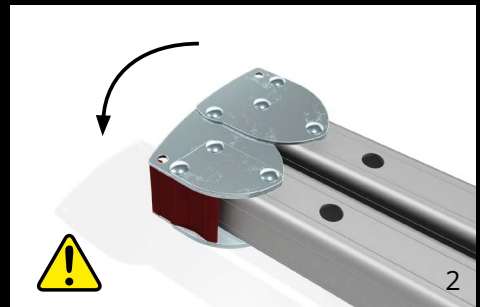
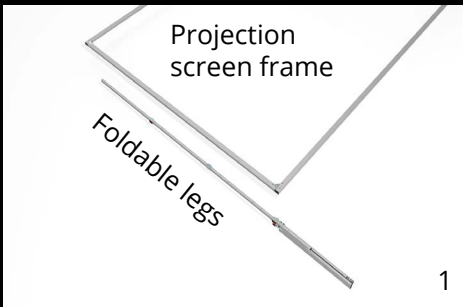

# LEG TYPES

Please mind the maximum set-up height of the legs:

**min:** minimum height of the bottom edge of the frame

**max:** maximum height of the bottom edge of the frame without additional safeguarding

Set-up heights are points of reference and have to be adapted in accordance with the screen size and ambient conditions. Set-up heights are based on absolute vertical alignment at indoors without additional force effects (e.g.: wind, air condition draught,..)

## HEIGHT ADJUSTMENT IN STEPS OF 6" (152,4MM)

compatible with all mobile AV Stumpfl screen systems

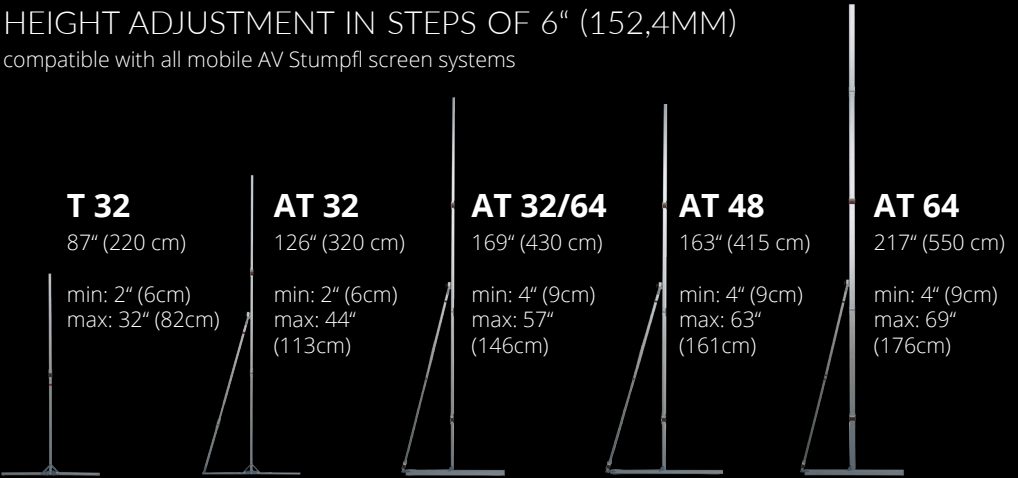

When a high degree of stability is needed, especially with large screens or a high set-up height, we recommend using following legs: AT32 for MONOBLOX 32 and AT48 or AT64 for MONOBLOX 64. AT-Legs have a telescopic support that is tightened with two wing screws.

## HEIGHT ADJUSTMENT IN STEPS OF 1" (25,4MM)

According to the screen frame height and the desired set-up height the legs can be put together in different lengths.

For detailed information, please refer to the corresponding manual T32-SHIFT or manual AT64-SHIFT.

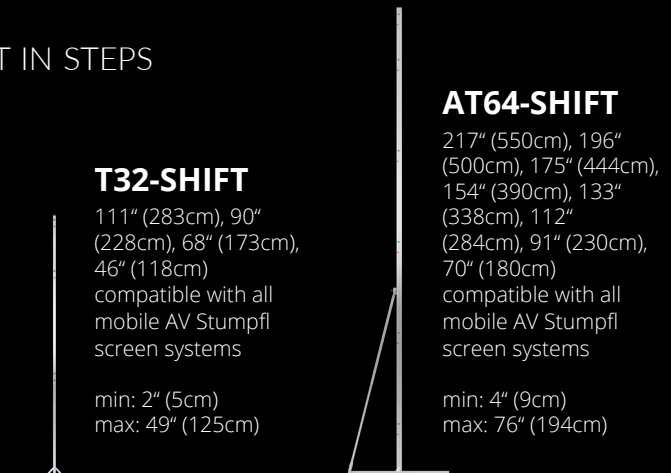

# SURFACE MOUNTING

Lay out the surface on the frame with the label „OBEN-TOP“ corresponding with the upper frame bar.

Press on the projection surface by starting at one corner and fasten the buttons one by one. Please mind the instructions for projection surfaces in chapter OPERATION, MAINTENANCE and SERVICE.

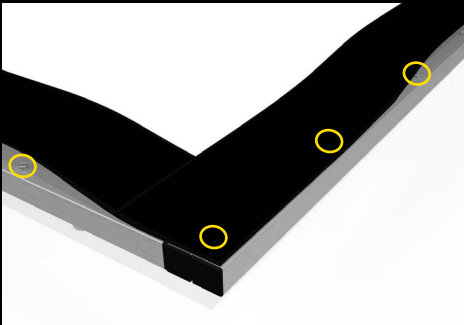
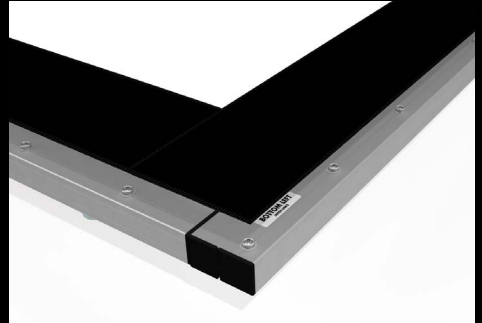
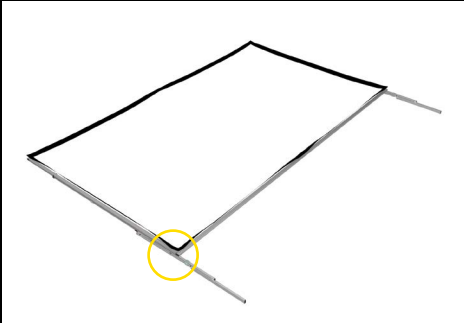



# SET UP

**1** Lift the projection screen with one person at each of the top corners and put it up by supporting the screen along the vertical frame elements.

To avoid mechanical overload and damage of the screen elements and legs with large screens or high set-up height, the screen has to be raised with an appropriate number of persons or rather by using hoisting devices.

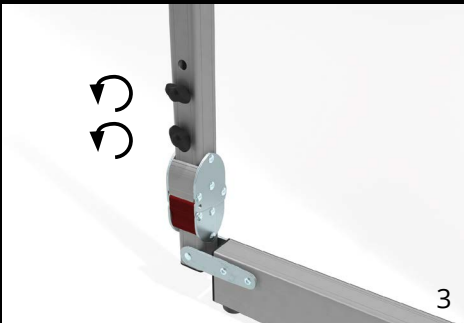
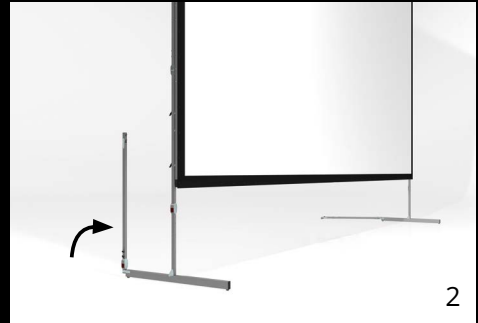
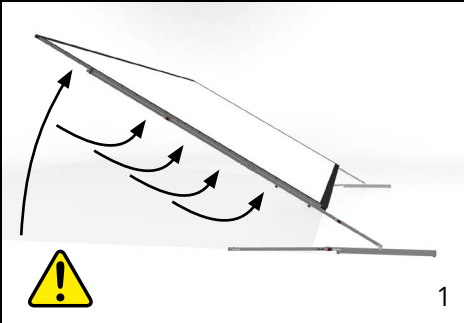

## TELESCOPIC SUPPORT ATTACHMENT

**2** Raise the telescopic support. **3** Untighten the wing screws. **4** Bolt the telescopic support with the wing screw M8x50mm (yellow). **5** Finally retighten the telescopic support clamp.

**⚠ WARNING** Beware of falling parts!

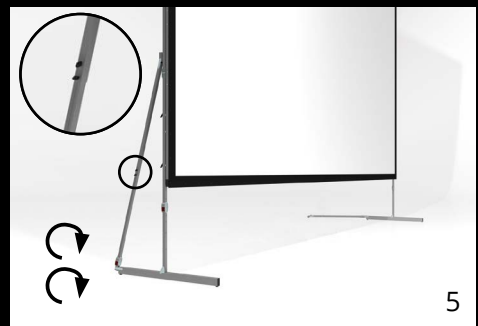
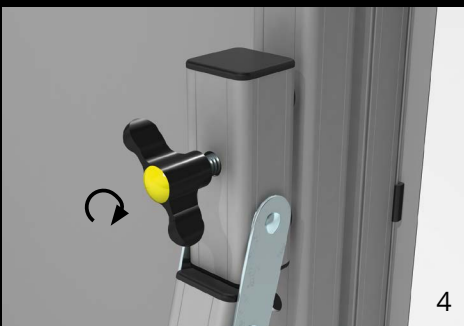

# DISMANTLING

Open the shear joints and telescopic leg supports with one person next to each of the foldable legs. Bring down the screen by supporting the screen along the legs and vertical frame elements towards the top corner edges.

**⚠ WARNING** Beware of falling parts!

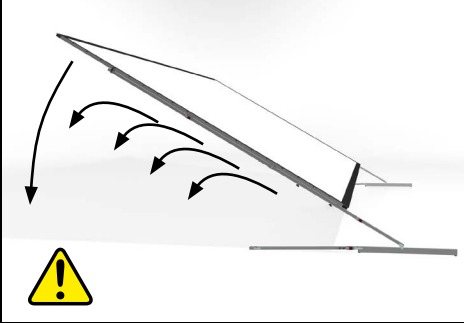

# ACCESSORIES

## ANTI-SWAY BRACE

To increase the side-stability of the projection screen the in length variable Anti-Sway Brace has to be screwed on the leg and clamped to the basic frame.

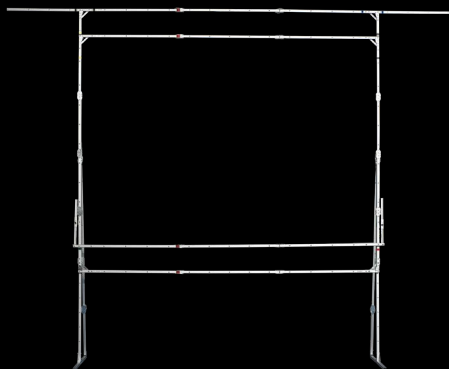

## DRAPEKIT

To drape a projection screen with decoration curtains. Depending on requirements, various frame parts can be used to attach the drapes Valance Bar (top drape), Wing Bar (left and right drape) and Skirt Bar (bottom drape - height adjustable for aspect ratio change) Heavy drapes have to be attached after the set up to avoid damaging of frame parts!

## EASYFLY™

### SUSPENSION CLAMP WITH EYEBOLT

This adapters for Monoblox can be attached quickly and easily at any point. The eyebolt fixes the adapter to the profile, offering professional hanging possibilities. Available for profile sizes 32x32mm and 64x32mm. max. load 30 kg/60 lbs.





## SET UP SUPPORT

The optional available set up support allows an easy mounting of the legs. By means of the 4 round bar holders the wings screws can be bolted by one person only without holding the frame and leg in position.

## FLIGHT CASE

As an option we offer sturdy, stackable transport cases with rollers for all mobile projection screens.

Transport case small: size 123 x 38 cm, height 34 cm

Transport case large: size 134 x 38 cm, height 37 cm

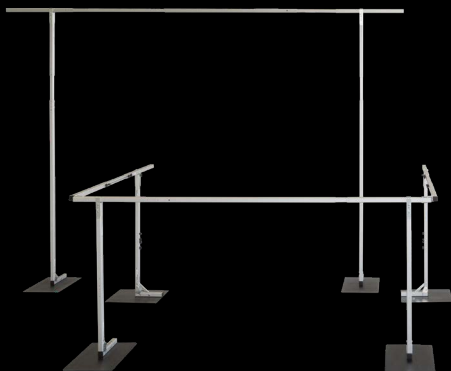

## DRAPE RUNOFF

This universal and transportable Drapery System can be used as independent partition, to mark out control areas or to allow flexible room design. A few elements combined with the telescopic system suffice to accomplish a variety of decorative purposes – no tools required. The decoration material is attached by Velcro fasteners.



AV Stumpfl GmbH | Mitterweg 46 | 4702 Wallern  
AVstumpfl@AVstumpfl.com | www.AVstumpfl.com | +43 7249 42811